

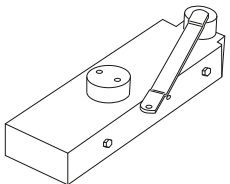

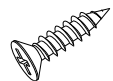

# RiEx

	A	1x		J	8x
			4x16		
	B	1x		K	12x
			M4x6		
	C	2x		L	2x
			M5x15		
	D	1x		M	3x
			M6x30		
	E	1x		N	2x
			M5x40		
	F	2x		O	2x
	G	2x			
	H	2x		P	2x
			Ø5		
	I	2x		Q	2x
			M5		
				R	
				S	

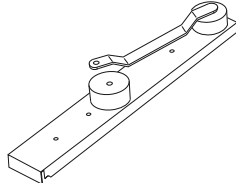
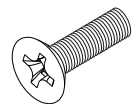
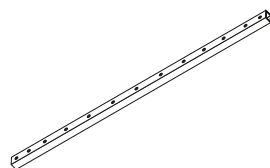
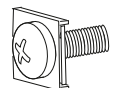
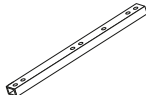
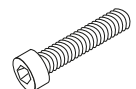
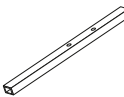
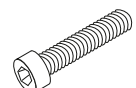
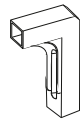
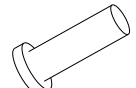

2

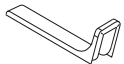
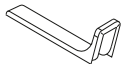
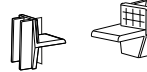
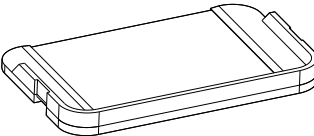
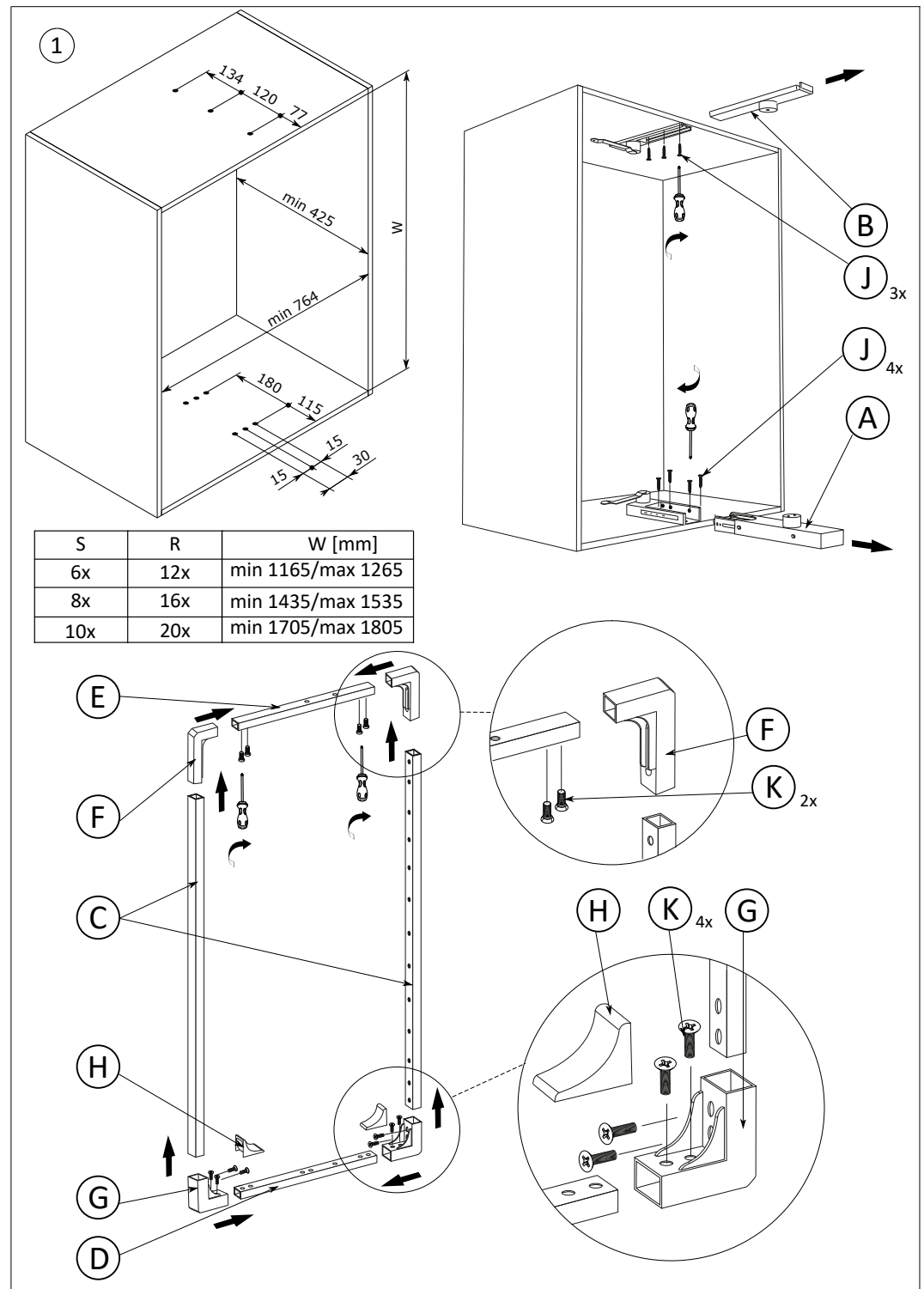
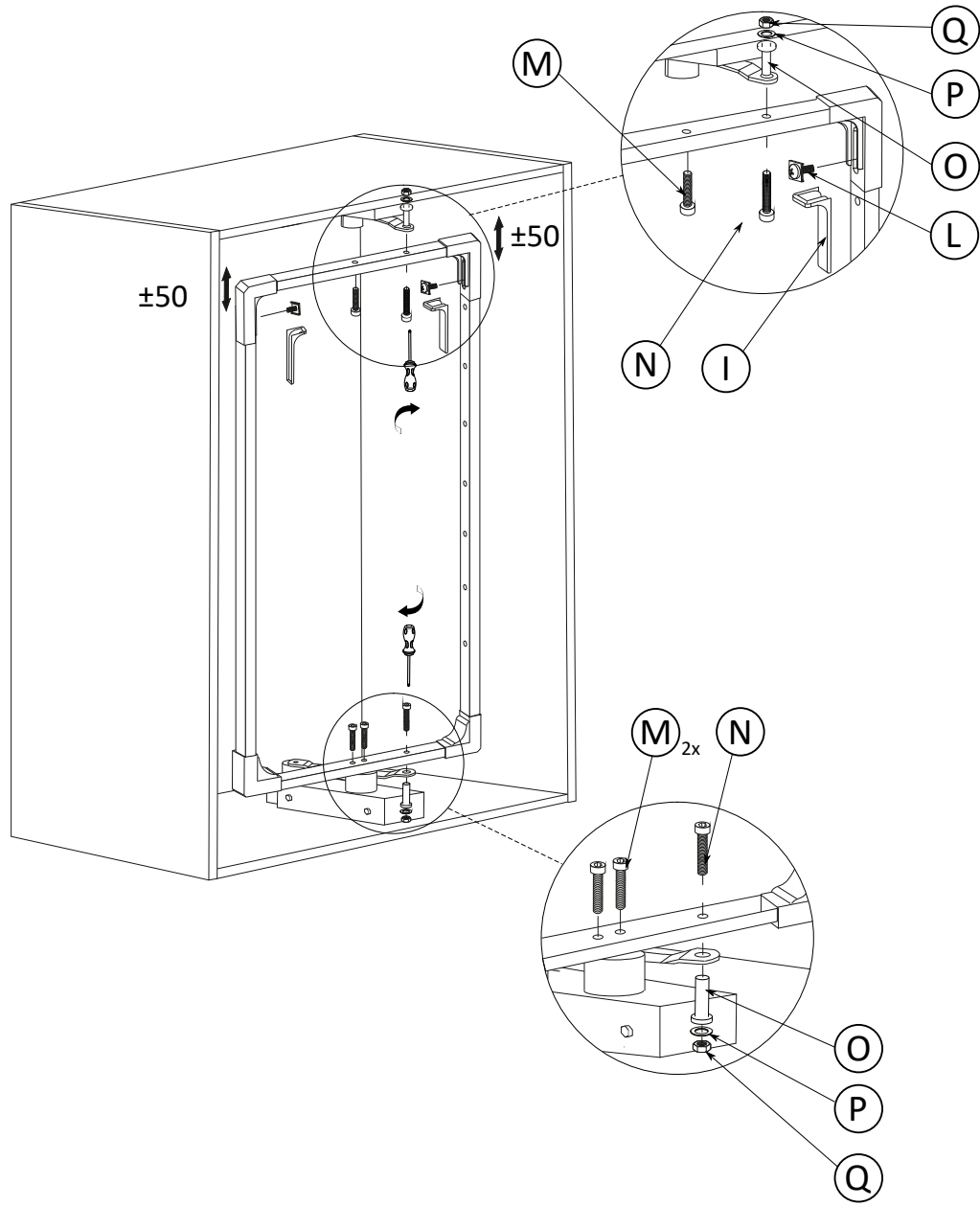

3

